

WEATHERPROOF WALL MOUNT EXIT









Weatherproof and Robust Wall Mount

The Weatherproof Wall Mount Exit is ideal for applications that require an IP66/67 rated exit that is available in a 24m viewing distance.

Fitted with 100K hour LEDs and built with a robust polycarbonate base and diffuser it is perfect for applications in warehouses, factories and stadiums.



Applications

- | | |
|--|--|
|  Schools |  Public Amenities |
|  Factories |  Stadiums |
|  Car Parks |  Warehouses |

Features and Benefits

- AS/NZS 2293.3 compliant
- Wall mount
- All directional decals in one box
- Lithium Iron Phosphate or Nanophosphate® battery
- Clevertest Plus System compatible

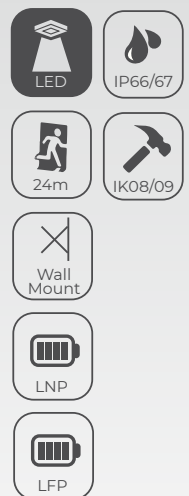

LP LITHIUM IRON PHOSPHATE
PREMIUM
PREMIUM PROJECT PERFORMANCE

L10 LITHIUM NANOPHOSPHATE®
OPTIMUM
NOTHING ELSE COMPETES WITH NANOPHOSPHATE®

WEATHERPROOF WALL MOUNT EXIT

ORDERING INFORMATION		LP	L10
TEST OPTIONS / PART #	Standard	CWELED-WM	LWELED-WM
	Clevertest Plus System/ Self-Test Capable	Yes	
	DALI	CWELED-DALI-WM	LWELED-DALI-WM
	Zoneworks® XT Hive	CWELED-HV-WM	LWELED-HV-WM
Carton Quantity		4	
Weight - Single (Carton)		2.8kg (14kg)	2.8kg (14kg)
Dimensions (L x W x H)		380mm x 130mm x 190mm	380mm x 130mm x 190mm
Directional Options		All Directional Inserts Included	

POWER, LAMPS AND BATTERY	LP	L10
Power Consumption (Standby / Max)	2.7W / 5.1W	2.5W / 4.8W
Lamp(s)	100,000hrs LEDs	
Battery	Lithium Iron Phosphate	Lithium Nanophosphate®
Voltage (V) / Capacity (mAh)	3.2V / 1500mAh	3.3V / 2500mAh
Charging Method	Intelligent Current Limited Constant Voltage	

TECHNICAL SPECIFICATIONS	CLASSIFICATION		
	LP	L10	
Operating Mode	Maintained		
Voltage (V) Frequency (Hz)	240V AC / 50Hz		
Construction - Body / Diffuser	PC / PC		
Mounting Type	Wall Mount Single Sided		
Operating Temperature	0°C to 40°C		
Ingress Protection Rating (IP)	IP66/67		
Impact Rating (IK)	IK08 (Side) & IK09 (Front)		
	C0	E1.6	E1.6
	C90	E1.6	E1.6

SPACING TABLE AND MOUNTING HEIGHTS – AS/NZS 2293.1:2018 (MINIMUM LIGHT LEVEL OF 0.2 LUX)									
Classification	2.1m	2.4m	2.7m	3.0m	3.3m	3.6m	4.0m	4.5m	5.0m
E1.6	4.6	4.7	4.6	0.0	0.0	0.0	0.0	N/A	N/A

For 1 lux and AS/NZS 2293.1:2005 spacing tables please visit: <https://clevertronics.com.au/spacing-tables/>

Based on minimum light level of 0.2 lux. Maximum allowed mounting height is 2.7m but for exceptions see AS/NZS 2293.1. Spacing classifications do not apply for theatre versions.

*Warranty information located at: <https://clevertronics.com.au/warranty-statement/>

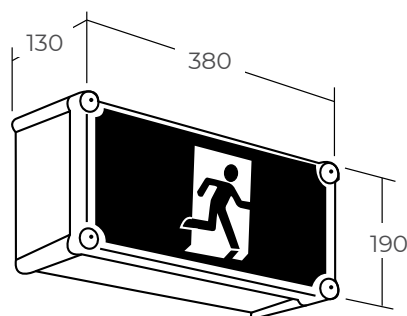

Dimensions (mm)

clevertronics.co.nz
clevertronics.com.au

1 Caribbean Drive, Scoresby VIC 3179
P +61 3 9559 2700 F +61 3 9559 2799 E info@clevertronics.com.au

Clevertronics is committed to continuously improving its products.
All features and specifications are subject to change without prior notice.
_PRODUCT SHEETS – ANZ Weatherproof Wall Mount 02OCT23

